

# 24" LED FHD Monitor

MW3224-V



## Key Features

- True color display and perfect color reproduction
- Wide viewing angle:178°(H)/ 178°(V)
- No color shift from any view angle
- Specific menu design, which is simple to operate
- Support 7\*24 working and lower power consumption
- Adaptively recognize signal
- VESA stand bracket
- High fidelity digital processing for a brilliant and vivid video
- Professional thermal design to extend equipment lifespan
- Screen can reduce blue light, protect eyes
- Without ripple, use smooth dimming with DC to eliminate screen flicker
- Three sides super slim design, min width can be 2.8mm
- High light transmittance, uniform brightness, rich color, wide color gamut

## Specifications

Model	MW3224-V
<b>Display</b>	
Display Type	LED Backlight
Screen Size	23.8"
Aspect Ratio	16:9
Pixel Pitch(mm)	0.2745*0.2745
Max Resolution	1920*1080
Brightness(cd/m <sup>2</sup> )	250
Contrast	3000:1
Response Time(ms)	19
Color	16.7M
Viewing Angle	Horizontal 178°, Vertical 178°
Refresh Rate	60Hz
<b>Interface</b>	
Input	1*VGA、1*HDMI
<b>Audio</b>	
Audio Input	1, 3.5 mm mini-jack
Speaker	2*1.5W
<b>OSD</b>	
Multi- Language	8(English, France, Spanish, German,Russia,Korea,Japanese,Simplified Chinese )
<b>Mounting</b>	
VESA	100mm * 100mm
Wall-mounted Thread	4-M4 Threaded hole, depth 10mm
<b>General</b>	
Power supply	DC 12V, 2A
Consumption	<24 W(on) <0.5 W(Standby)
Operation Temperature	0°C ~ 40 °C(32°F~104°F)
Operating Humidity	20%~85% (No Condensation)
Storage Temperature	-10°C ~50°C (14°F~122°F)
Storage Humidity	10%~90% (No Condensation)
Dimension (W*H*D) (mm)	541.8*412.6*200 (With Pedestal)
Package(W*H*D)(mm)	606*405*125
Weight	Net Weight:3.3Kg(7.28Lb) Gross Weight:4.6Kg(10.14Lb)
<b>Accessory</b>	
Standard	HDMI cable、Power cable、Adapter、 Pedestal、 Quick Guide
Optional	Hanging bracket(Model: HB-4022-E)

## Appearance

## Dimensions

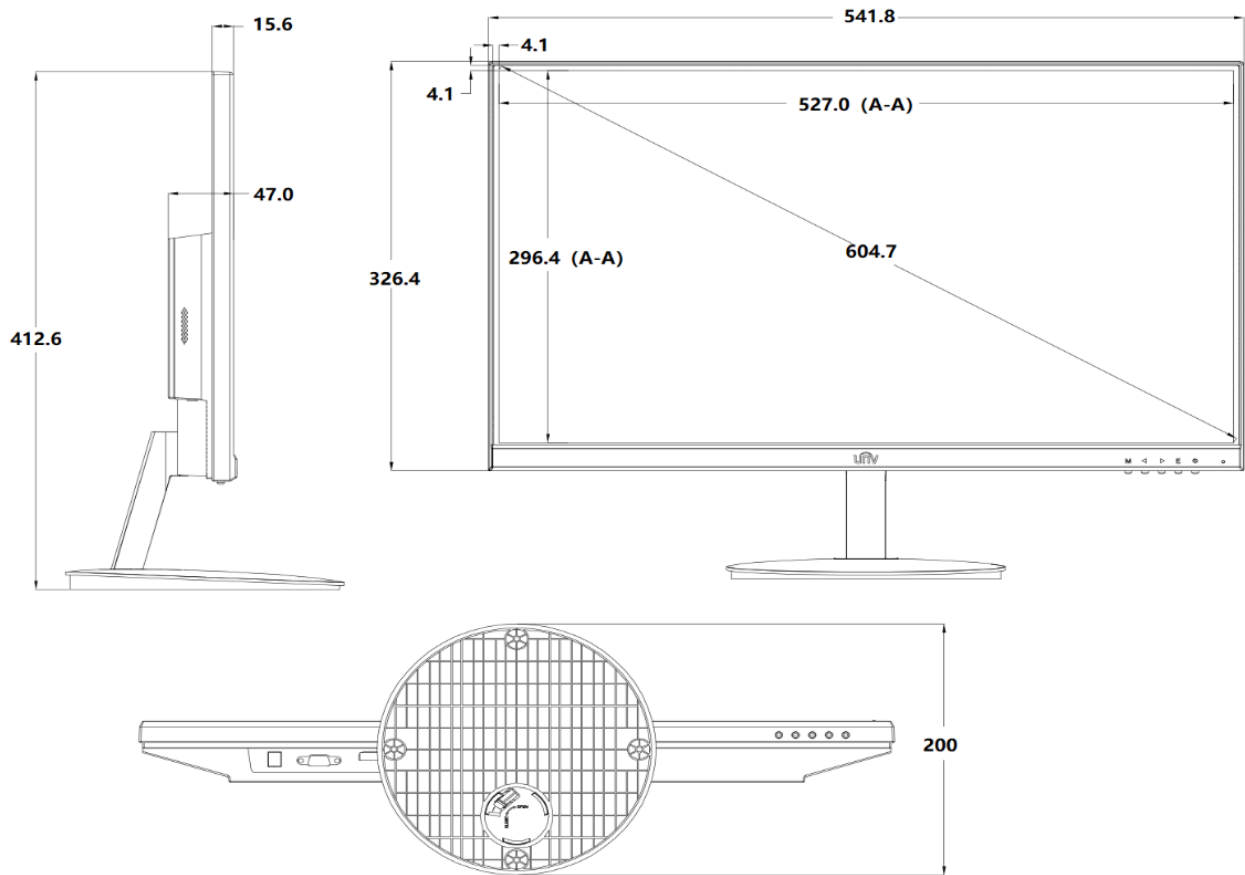

## Interfaces

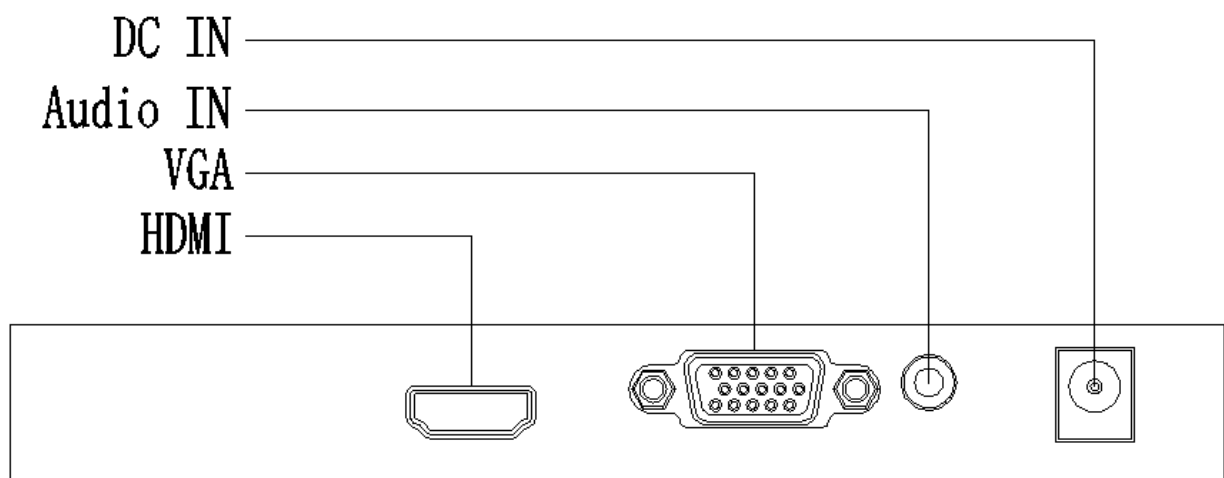

**Zhejiang Uniview Technologies Co.,Ltd.**

Building No.10, Wanlun Science Park, Jiangling Road 88, Binjiang District, Hangzhou, Zhejiang, China

Email: [overseasbusiness@uniview.com](mailto:overseasbusiness@uniview.com); [globalsupport@uniview.com](mailto:globalsupport@uniview.com)

<http://www.uniview.com>

©2023 Zhejiang Uniview Technologies Co.,Ltd. All rights reserved.

\*Product specifications and availability are subject to change without notice.